

PSC-CMS-2W-HS-LT15

Infrared thermometer for measurement of smallest temperature differences of 0.025°C

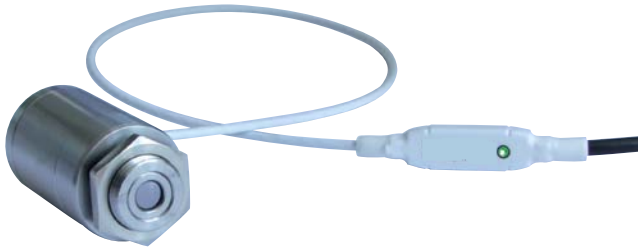

FEATURES

- New benchmark in low noise IR-thermometry
- Suitable for relative measurement of smallest temperature differences of 0.025°C
- Touches the physical limits ensuring low ambient temperature drift
- Green LED alarm indication, aiming support, self diagnostic or temperature code indication
- Complete solid state design without any moving parts
- Assures usability of a new class of ultra low noise level IR thermometers
- Stainless steel housing with compact dimensions

General specifications

Environmental rating	IP 65 (NEMA-4)
Ambient temperature	-20°C to 75°C ¹⁾
Storage temperature	-40°C to 85°C
Relative humidity	10 - 95%, non condensing
Vibration	IEC 68-2-6: 3 G, 11-200 Hz, any axis
Shock	IEC 68-2-27: 50 G, 11 ms, any axis
Weight	200 g

Electrical specifications

Output/analog	4-20 mA
Output/alarm	0-30 V/500 mA (open collector)
Output/digital	uni-/bidirectional, 9.6 kBaud, 0/3V digital level, USB (option)
Input	Programmable functional input for triggered signal output or peak-hold function
Loop impedance	1000 Ω ²⁾
LED functions	alarm indication, automatic aiming support, self diagnostic, temperature indication (via temp. code)
Cable length	1 m standard, 3.5 m optional (0.5 m between sensing head and electronics)
Power supply	5-30 V DC

Measurement specifications

Temperature range	-20°C to 150°C
Spectral range	8 - 14 μm
Optical resolution (90 % energy)	15:1
CF-Optics (optional)	0.8 mm @ 10 mm
System accuracy	± 1.0% or ± 1.0°C ^{1), 2), 3)}
Repeatability	± 0.3% or ± 0.3°C ^{1), 2), 3)}
Temperature coefficient	± 0.05 K/K or ± 0.05 % K ⁴⁾
Temperature resolution	0.025 K ³⁾ (AVG > 0,2 s)
Response time	150 ms (adjustable up to 999 s via optional programming device)
Emissivity/Amplification (adjustable via software)	0.100 - 1.100
Transmissivity (adjustable via software)	0.100 - 1.100
Signal processing (parameter adjustable only via optional software)	peak hold, valley hold, average; extended hold function with threshold and hysteresis
Dimensions of electronics	Length: 35 mm Diameter: 12 mm
Software	PSC Compact Connect

¹⁾ whichever is greater

²⁾ at ambient temperature 23 ± 5°C

³⁾ for temperatures > 20°C

⁴⁾ for ambient temperatures <18°C and >28°C; whichever is greater

¹⁾ for Vcc (supply voltage) 5-12 VDC/ at Vcc > 12 VDC the max. ambient temperature of the electronics is 65 °C

²⁾ in dependence on supply voltage

PSC-CMS-2W-HS-LT15

Optical Specifications

Optics, D:S = 15:1

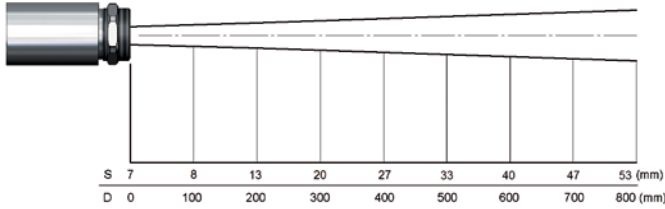

Optics with CF-lens, D:S = 15:1

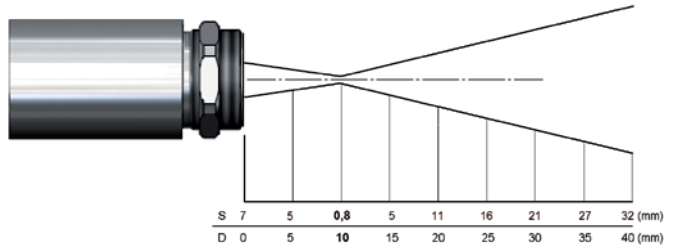

Dimensions/Interfaces

Analog Mode (Two wire connection)

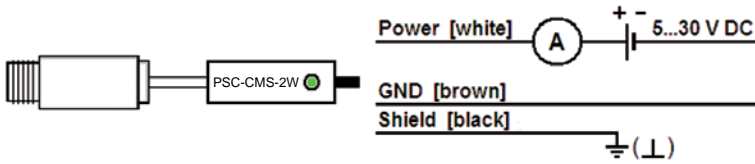

Dimensions PSC-CMS-2W

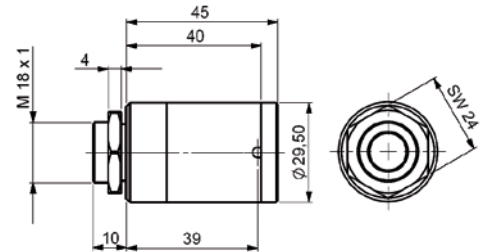

Connection analog with open collector alarm output

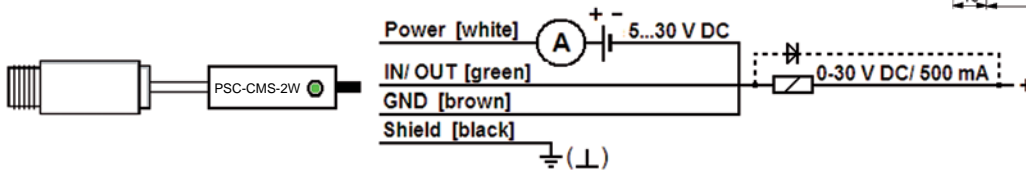

Combined Mode (analog and digital)

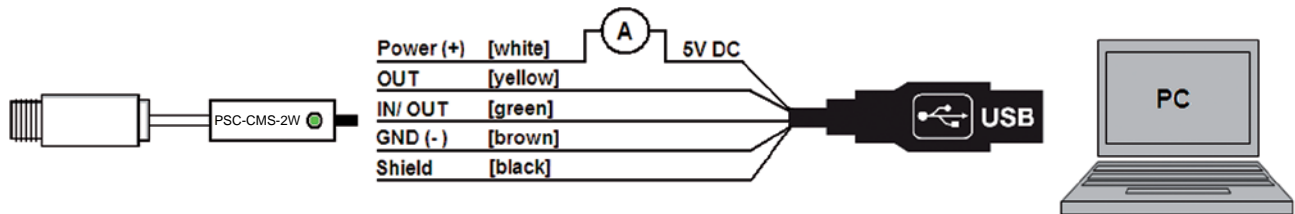

Dimensions/Accessories (examples)

Mounting bracket, adjustable in one axis (AC-SSS-FBMH)

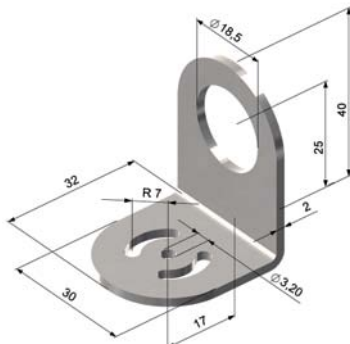

Air purge collar (AC-SSS-APMH)

